

**Microphone Amplifier
and Limiter**
330-510

Specified for Dyn. mic. and Condenser mic.

CONTENTS:

Technical Specifications
Diagram
Component Lay-out
Partslist

DRAW - NO:

330-5111-A4
330-5130-A3
330-5141-A4
330-5131-A4

	Supply Voltage	$\pm 15 \text{ V} \pm 10\%$
	Current Consumption	approx. 48 mA
	Microphone gain (adjustable on R3)	58 dB ± 1 dB
X)	Limiter level ref. to output, no load	+ 6 dBu $\pm 0,5$ dB
	Limiter range	> 30 dB
	Input impedance, balanced floating	2 K Ω $\pm 15\%$
	Output impedance, balanced floating	< 40 Ω
	Load on output not lower than	200 Ω
	Frequency response -3dB points	70 Hz to 20 kHz
	Noise ref. to input	-126 dBu A-curve
	Distortion at +5dBu output 1kHz	< 0,3%
	Distortion at 20dB limiting 1kHz	< 0,3%
	raising to 2% at 50 Hz	
X)	Attacktime	1,5 msec combined
	with a fullwave logarithmic clipping circuit	
	Recovery time, double time constants	200 msec upon 15 sec.
	LED indicator on front panel lights up during limiting.	
	Connector	Tuchel T 2700
	Mechanical Outline N-cassette B1 module front :	40 x 95 mm
	depth :	103 mm
X)	Peaks shorter than 1,5 msec duration is limited to a level	
	max. 3 dB above steady state limiter level.	
	Connections:	
	Tuchel pin 10	+ 15 volts supply voltage
	Tuchel pin 11	- 15 volts supply voltage
	Tuchel pin 12	0V, reference
	Tuchel pin 13	Chassis
	Tuchel pin 17 and 16	Output, balanced floating
	Tuchel pin 1 and 23	Microphone Input
	Tuchel pin 2	+48Volts Phantom supply
	Tuchel pin 22	0V, Phantom supply (mic. cable screen)
	Cannon pin 2	Micr. input floating
	Cannon pin 1	Screen microphonecable

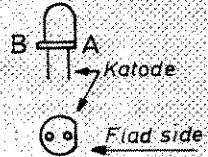
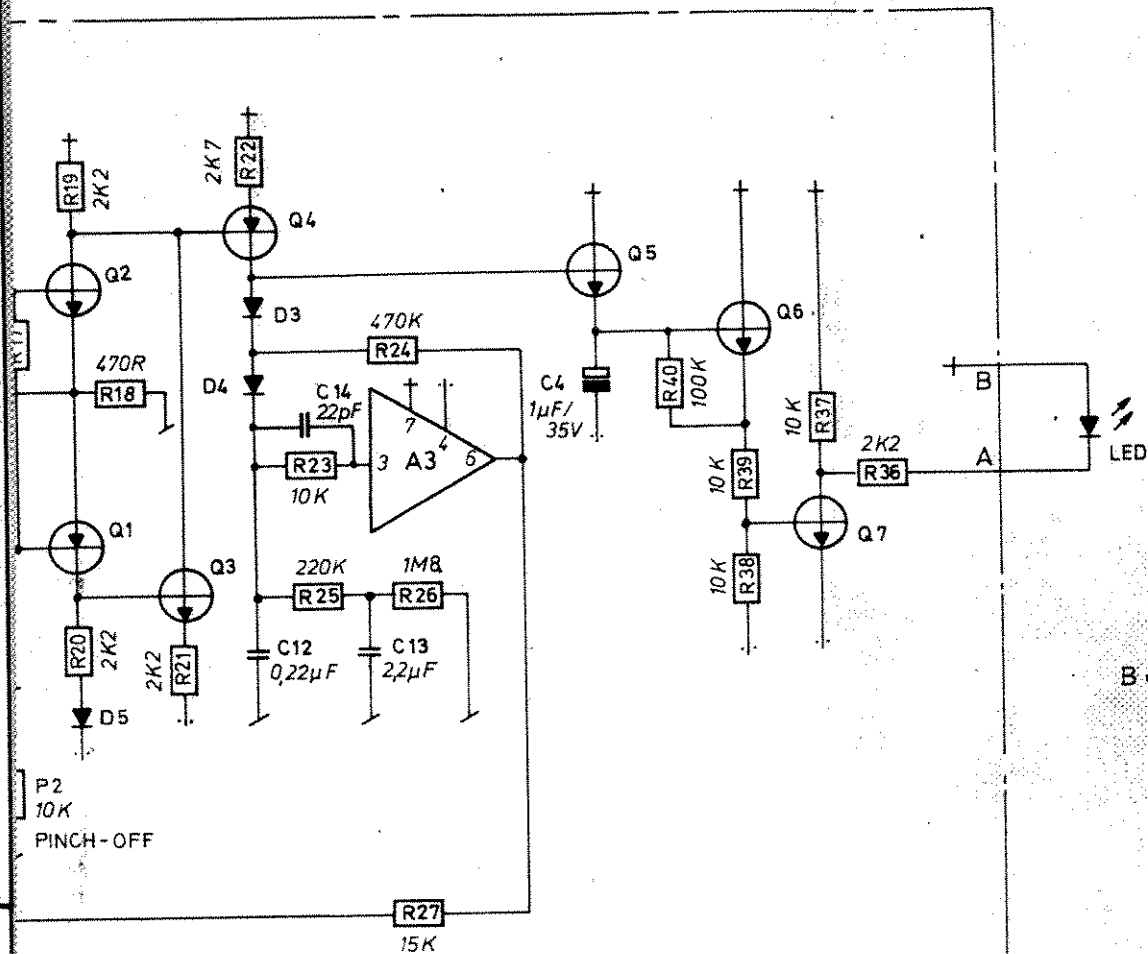

NTP 330-5040

Pos.:	Antal:	Materiale:	Behandl.:	Del at
Målestok:				
Tolerance:	mm	Microphone Amplifier and Limiter	330-510	
Tegnet:	16.175 IW	Diagram		
Godkendt:	B. M.			
Revideret:				
				330-5130-A-3

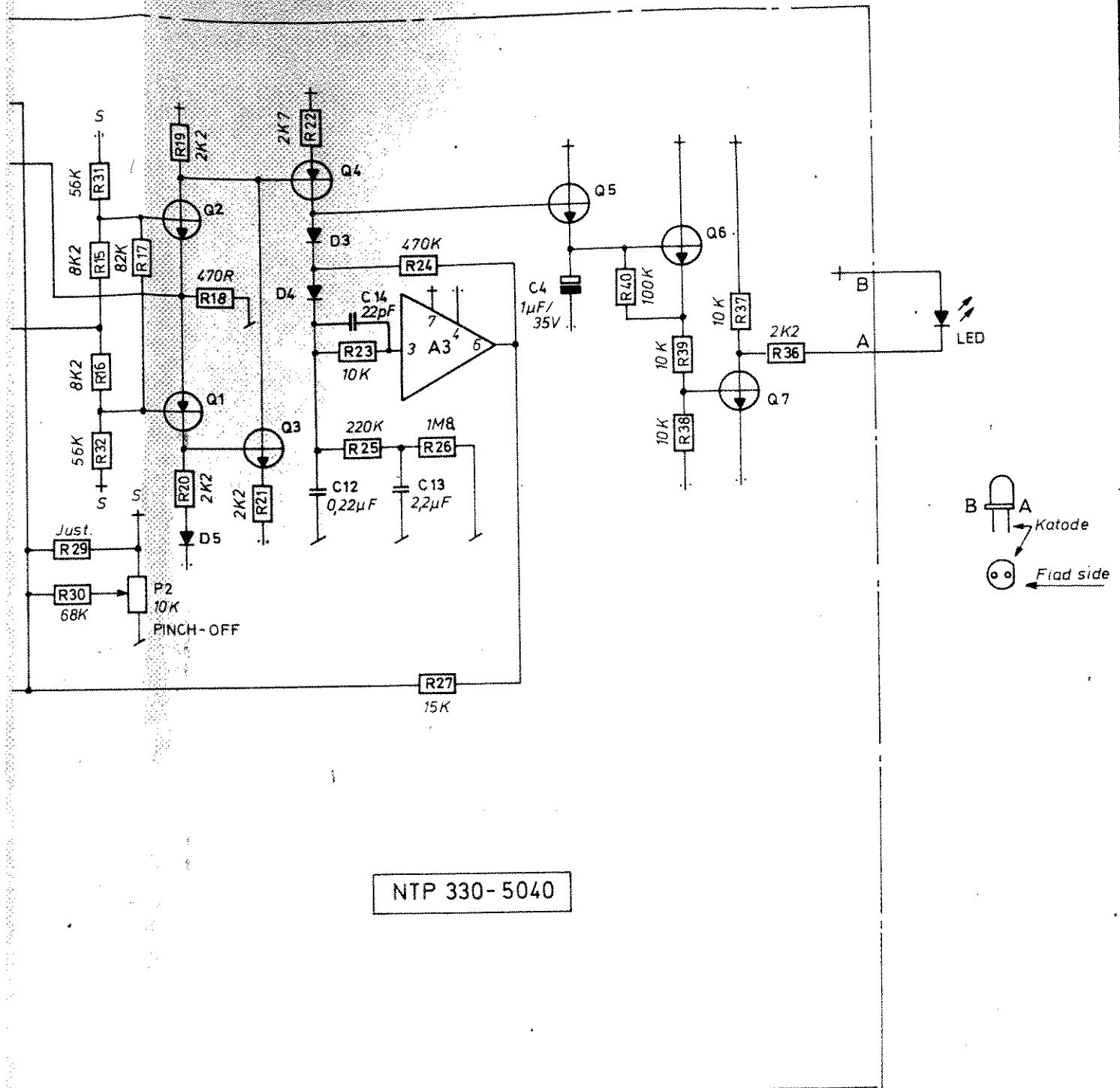

Pos	Antal	Materiale	Behandl	Del af
Målestok :				 N. TONNES PEDERSEN A/S 330-5130-A-3
Tolerance : mm		Microphone Amplifier and Limiter	330-510	
Tegnet : 16.175 IW		Diagram		
Godkendt : B. M.				
Revideret :				

TUCHEL
T 2700

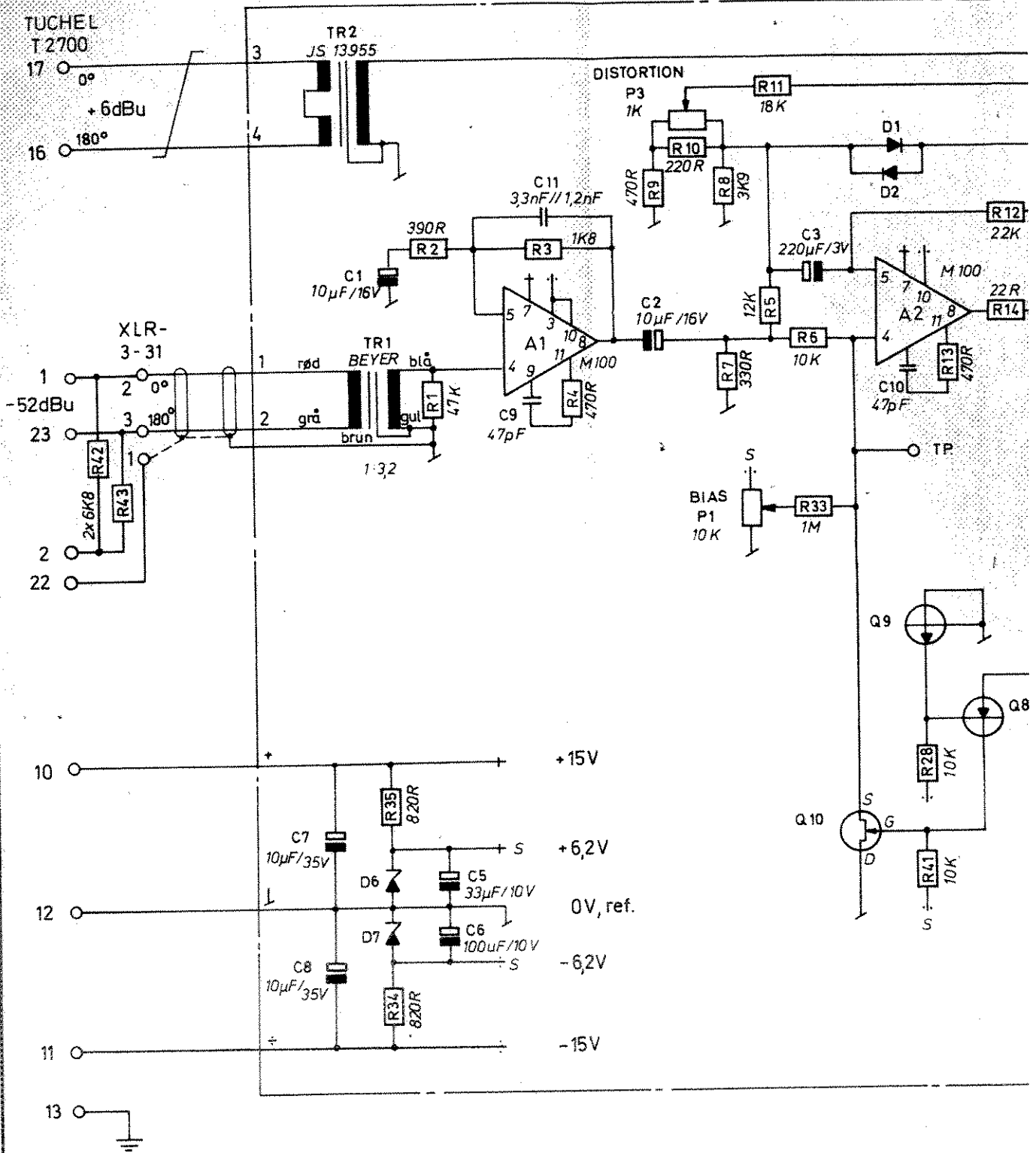

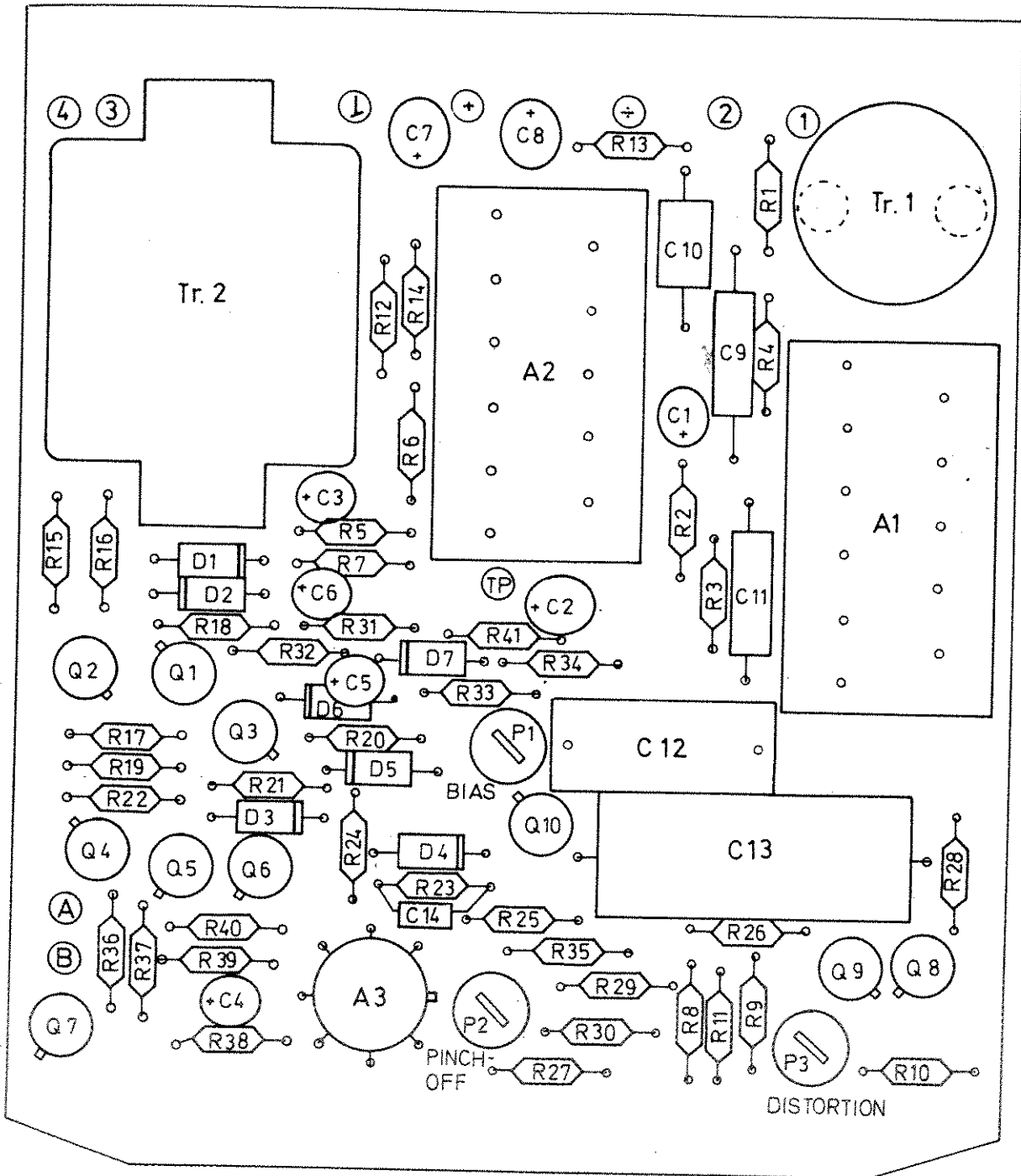

Pos.	Antal	Materiale	Behandl	Del af
Målestok	2:1	MICROPHONE AMPLIFIER and LIMITER 330-510		 N. TØNNES PEDERSEN A/S
Tolerance	mm	Component Lay-out		
Tegnet	16.1.75 IW			330-5141-A-4
Gødkendt	7/2-73 B.H			
Revideret				

POS DESIGN. REF.	ANT /QTY	BETEGNELSE / DESCRIPTION				LEV. FABRIKAT / SUPPL. MANUFACT.
R1		Resistor	47K	1/8W	5%	Resista SK2
R2		"	390R	"	"	"
R3		"	1K8	"	"	"
R4		"	470R	"	"	"
R5		"	12K	"	"	"
R6		"	10K	"	"	"
R7		"	330R	"	"	"
R8		"	3K9	"	"	"
R9		"	470R	"	"	"
R10		"	220R	"	"	"
R11		"	18K	"	"	"
R12		"	22K	"	"	"
R13		"	470R	"	"	"
R14		"	22R	"	"	"
R15		"	8K2	"	"	"
R16		"	8K2	"	"	"
R17		"	82K	"	"	"
R18		"	470R	"	"	"
R19		"	2K2	"	"	"
R20		"	2K2	"	"	"
R21		"	2K2	"	"	"
R22		"	2K7	"	"	"
R23		"	10K	"	"	"
R24		"	470K	"	"	"
R25		"	220K	"	"	"
R26		"	1M8	"	"	"
R27		"	15K	"	"	"
R28		"	10K	"	"	"
R29		"	adjusted	"	"	"
R30		"	68K	"	"	"
R31		"	56K	"	"	"
R32		"	56K	"	"	"
R33		"	1M	"	"	"
R34		"	820R	"	"	"
R35		"	820R	"	"	"
R36		"	2K2	"	"	"
R37		"	10K	"	"	"
R38		"	10K	"	"	"
R39		"	10K	"	"	"
R40		"	10K	"	"	"
R41		"	10K	"	"	"
R42		"	6K8 1/8W 0,5% (Vitrohm)			Resista MK2
R43		"	6K8 1/8W 0,5%			"
P1		Trim.pot.	3329H-103	10K		BOURNS
P2		"	3329H-103	10K		"
P3		"	3329H-103	1K		"

DATE/SIGN



Microphone Amplifier and Limiter
330-510
Partslist

STYKLISTE/PARTS LIST

Pag. 1 / (2)

No.: 330-5131-A-4

POS. DESIGN. REF.	ANT. QTY	BETEGNELSE / DESCRIPTION			LEV. FABRIKAT	SUPPL. MANUFACT.
C1		Tantal Capacitor	10µF	16V	ERO	
C2		" "	10µF	16V	"	
C3		" "	220µF	3V	"	
C4		" "	1µF	35V	"	
C5		" "	33µF	10V	"	
C6		" "	100µF	10V	"	
C7		" "	10µF	35V	"	
C8		" "	10µF	35V	"	
C9		Styroflex "	47pf	160V	Siemens	
C10	3,3// 1,2	" "	47pf	160V	"	
C11		" "	4,5nf	160V	"	
C12		Polyester "	0,22µF	250V	"	B32234
C13		" "	2,2µF	100V		
C14		Styroflex "	22pF	160V	ERO Siemens	
D1		Diode	BAX 13	(1N4152)	Texas (Miniwatt)	
D2		"	" 13	(1N4152)	" "	
D3		"	1N4148		"	
D4		"	1N4148		"	
D5		"	1N4148		"	
D6		Zenerdiode	1N821		Motorola	
D7		"	1N821		"	
Q1		Transistor	BC 177 B		Siemens	
Q2		"	BC 107 B		"	
Q3		"	BC 107 B		"	
Q4		"	BC 177 B		"	
Q5		"	BC 107 B		"	
Q6		"	BC 107 B		"	
Q7		"	BC 107 B		"	
Q8		"	BC 177 B		"	
Q9		"	BC 107 B		"	
Q10		F.E.T.	SI 216 N	Special	Akers	
A1		Operational Amplifier		M-100	NTP	
A2		" "		M-100	"	
A3		" "		LM 310	National Semi.	
Tr1		Input Transformer		BV 35803	BEYER	
Tr2		Output "		13955	J.S.	
LED		LED	TIL 209 with clip.		Texas	
		Cannon Conn.	XLR-3-31		ITT	
		Tuchel "	T 2700		Nordisk Elektronik	
		Print	330-5040-A4		NTP	

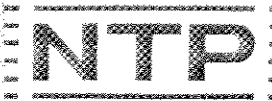
 NTP ELEKTRONIK A/S	Microphone Amplifier and Limiter	STYKLISTE/PARTS LIST
	330-510	Pag. 2 / (2)
	Partslist	No.: 330-5131-A-4